

Indicators					
STATUS	PAUSE	DATA	SUPPLIES	NETWORK	
					Ready
					Paused
					Cover Open
					Media Out
					Network Error
					Printhead Overtemp Error

Pause

Feed

Cancel

Configuration Report

Smart Calibration

<http://www.zebra.com/contact>

<https://km.zebra.com>

<https://www.zebra.com/supplies>

www.zebra.com/zd410d-info

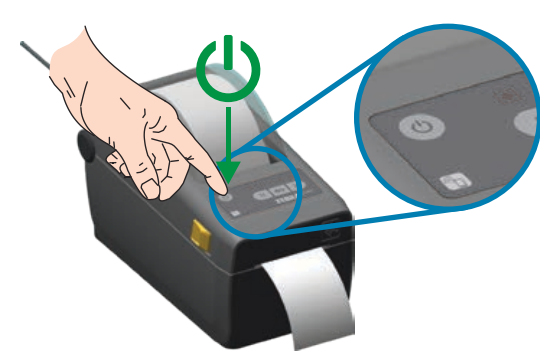
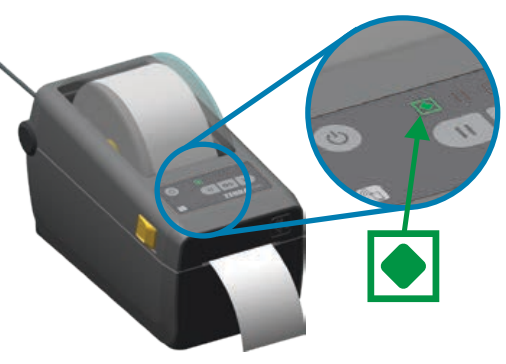
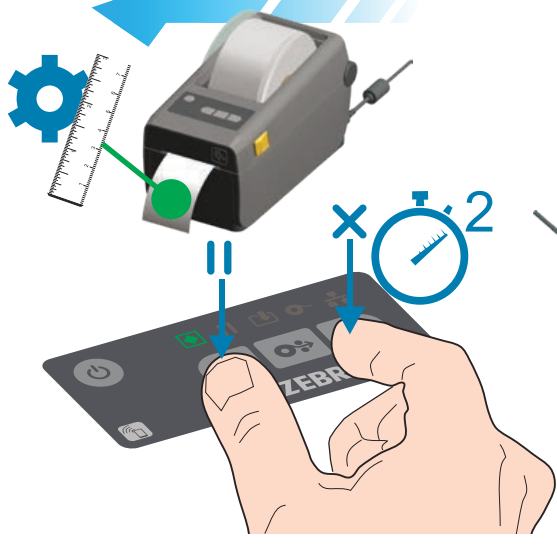
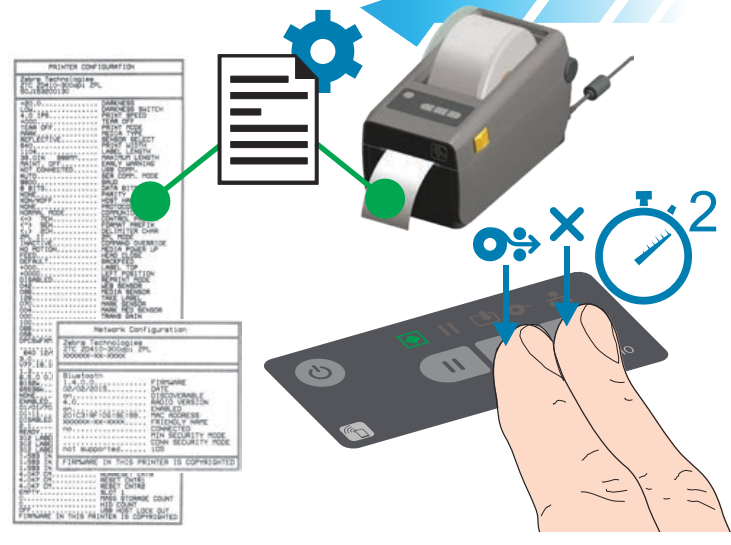
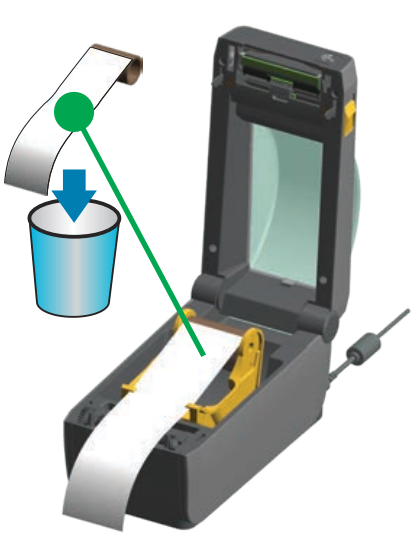



Learn About Genuine Zebra Supplies
<http://www.zebra.com/supplies>

Set Up Your Printer
<http://www.zebra.com/zd410d-info>

Install Latest Zebra Setup Utilities
<http://www.zebra.com/setup>



ZD410

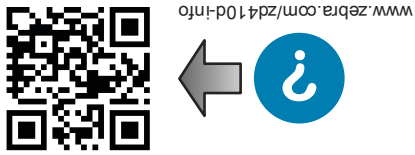
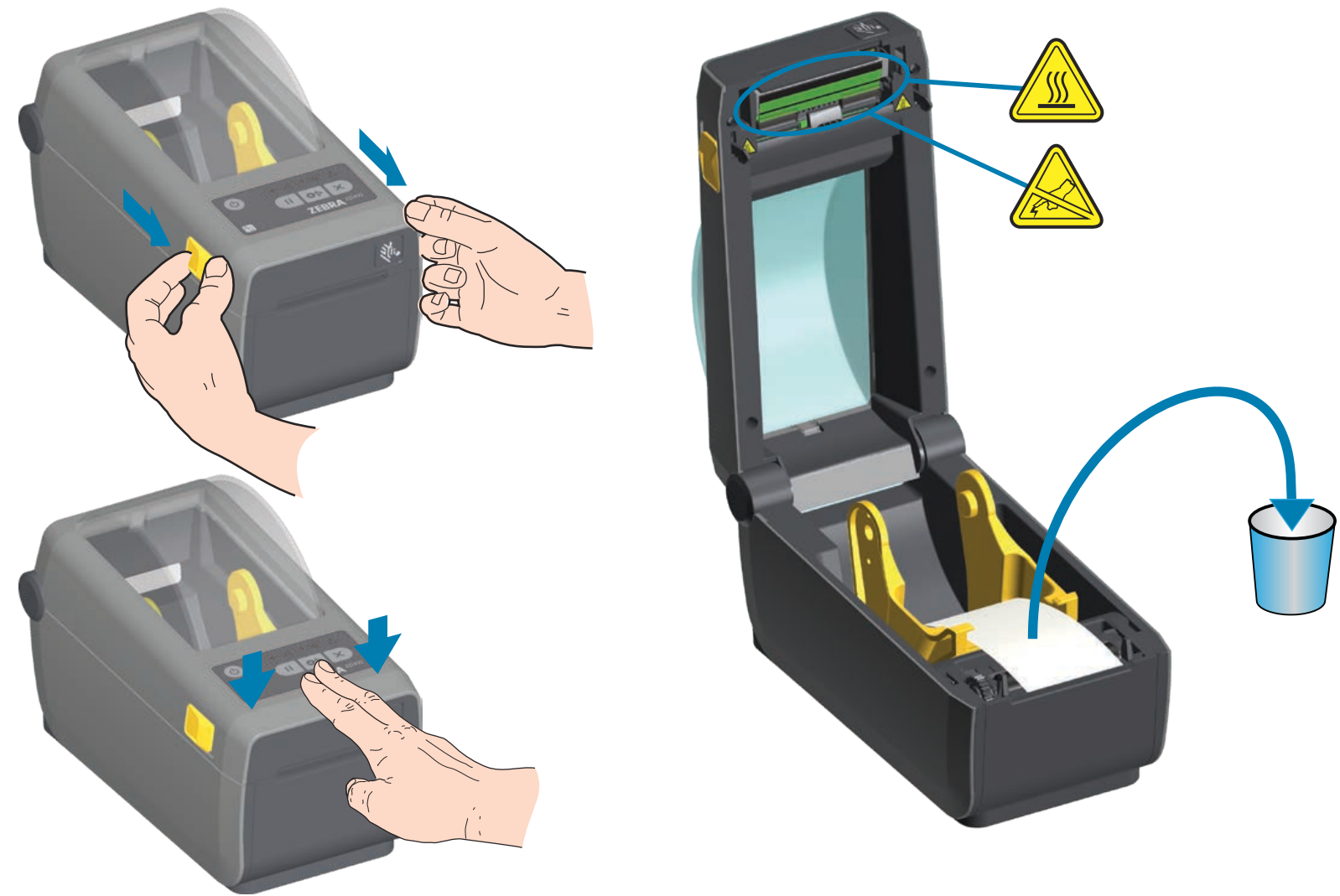

www.zebra.com/zd410d-info

1

www.zebra.com/setup



Download and Install Zebra Setup Utilities
Includes Windows Printer Driver Files

2

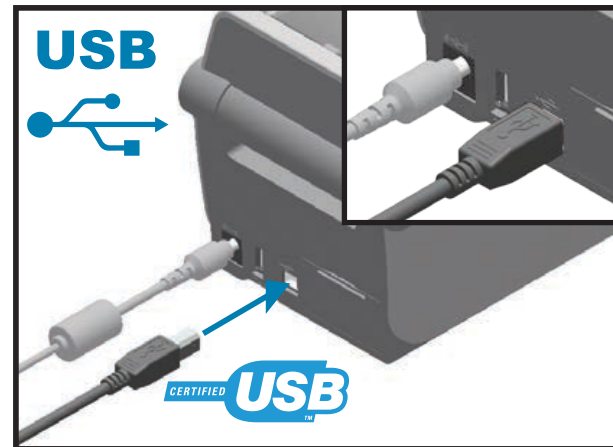

Connect a USB cable to the printer

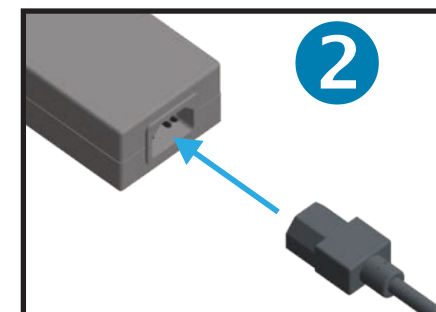
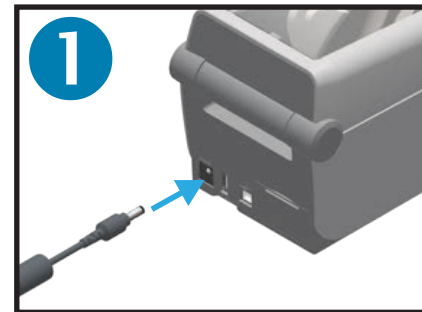

3

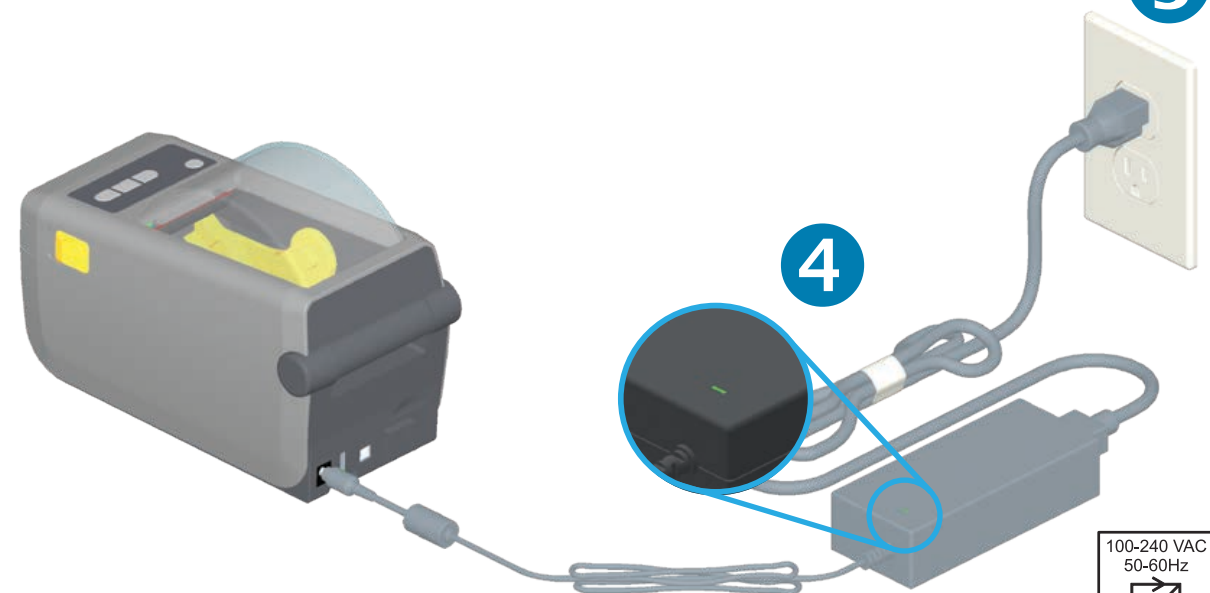

4

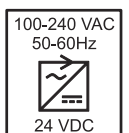

NA and Corporate Headquarters
+1 800 423 0442
inquiry4@zebra.com

Asia-Pacific Headquarters
+65 6858 0722
contact.apac@zebra.com

EMEA Headquarters
zebra.com/locations
mseurope@zebra.com

Latin America Headquarters
+1 847 955 2283
la.contactme@zebra.com

<http://www.zebra.com/locations>

©2018 ZIH Corp. and/or its affiliates. All rights reserved. Zebra and the stylized Zebra head are trademarks of ZIH Corp., registered in many jurisdictions worldwide. All other trademarks are the property of their respective owners.

Printed In China

